

INSTRUCTIONS

LED T8 Tube Series - Double & single ended bypass/line voltage



RAB Lighting is committed to creating high-quality, affordable, well-designed and energy-efficient LED lighting and controls that make it easy for electricians to install and end users to save energy. We'd love to hear your comments. Please call the Marketing Department at 888-RAB-1000 or email: marketing@rablighting.com

T8-9-24G-8XX-SD-BYP USA
T8-12-36G-8XX-SD-BYP USA
T8-10.5-48G-8XX-SD-BYP USA
T8-12-48G-8XX-SD-BYP USA
T8-14-48G-8XX-SD-BYP USA
T8-15-48G-8XX-SD-BYP USA



IMPORTANT

READ CAREFULLY BEFORE INSTALLING LED TUBE. RETAIN THESE INSTRUCTIONS FOR FUTURE REFERENCE.

RAB LED tube must be wired in accordance with the National Electrical Code and all applicable local codes. Proper grounding is required for safety. THIS PRODUCT MUST BE INSTALLED IN ACCORDANCE WITH THE APPLICABLE INSTALLATION CODE BY A PERSON FAMILIAR WITH THE CONSTRUCTION AND OPERATION OF THE PRODUCT AND THE HAZARDS INVOLVED.

WARNINGS:

WARNING - Risk of fire or electric shock. LED Retrofit Kit installation requires knowledge of luminaire electrical systems. If not qualified, do not attempt installation. Contact a qualified electrician.

WARNING - Risk of fire or electric shock. Install this kit only in the luminaires that have the construction features and dimensions shown in the photographs and/or drawings and where the input rating of the retrofit kit does not exceed the input rating of the luminaire.

WARNING -To prevent wiring damage or abrasion, do not expose wiring to edges of sheet metal or other sharp objects.

WARNING - To avoid potential fire or shock hazard, do not use this retrofit kit in luminaires employing shunted bi-pin lampholders. Note: Shunted lamp holders are found only in fluorescent luminaires with Instant-Start ballasts. Instant-start ballasts can be identified by the words "Instant Start" or "I.S." marked on the ballast. This designation may be in the form of a statement pertaining to the ballast itself, or may be combined with the marking for the lamps with which the ballast is intended to be used, for example F40T12/IS. For more information, contact the LED luminaire retrofit kit manufacturer.

SAFETY INFORMATION:

For your and others' safety, please read the precaution carefully before installation:

- (1). Switch off the power supply before commencing work, make sure correct connection before power on.
- (2). Suitable for use with the emergency equipment : DRI-5-EMGR-T8

PRODUCT FEATURES

- UL certified
- Full glass housing: no aging, yellowing, bending

Single ended

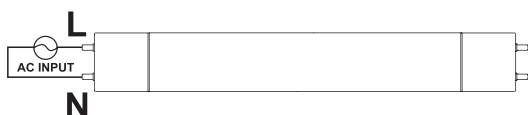

Double ended

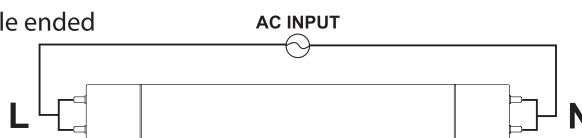

- Product applications: widely used in residential buildings, offices, shopping malls, supermarkets, hospitals, assembly lines, warehouses, etc. for energy-saving illumination.

RAB Lighting is committed to creating high-quality, affordable, well-designed and energy-efficient LED lighting and controls that make it easy for electricians to install and end users to save energy. We'd love to hear your comments. Please call the Marketing Department at 888-RAB-1000 or email: marketing@rablighting.com

INSTALLATION INSTRUCTIONS

The below ballast wiring represents typical configuration. The actual ballast wiring varies according to ballast model. The socket should be non-shunted.

Single ended wiring Instruction

Retrofit luminaire with 1 lamp

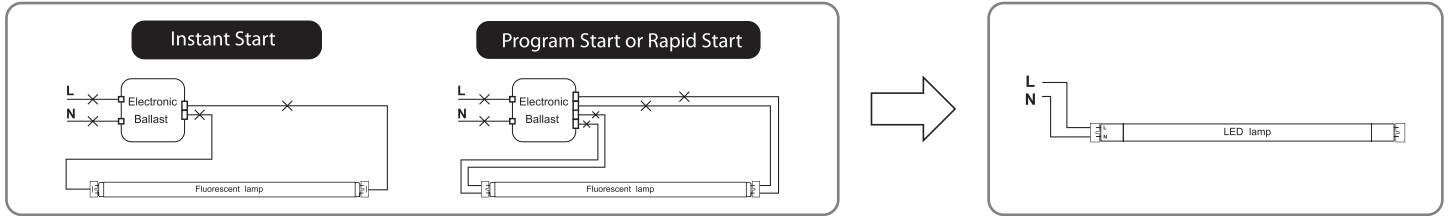

Retrofit luminaire with 2 lamps

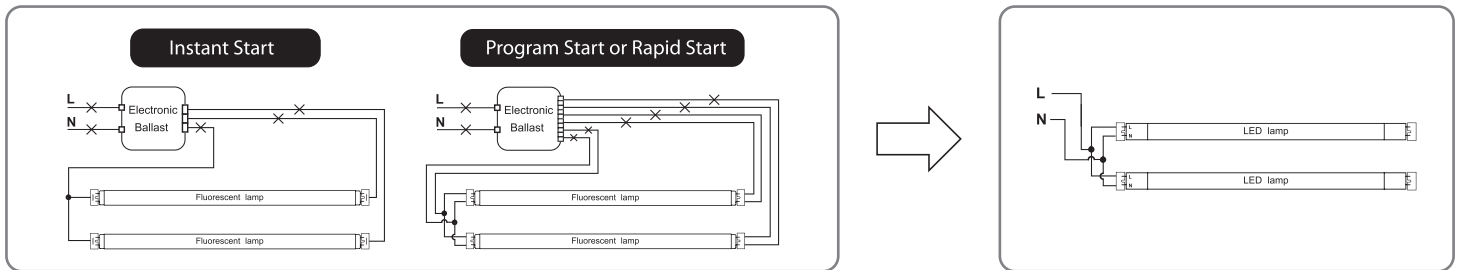

Retrofit luminaire with 3 lamps

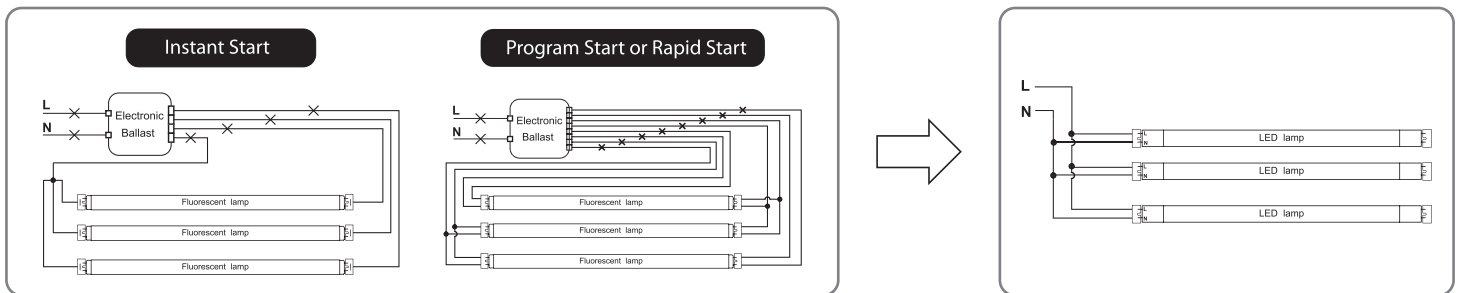

Retrofit luminaire with 4 lamps

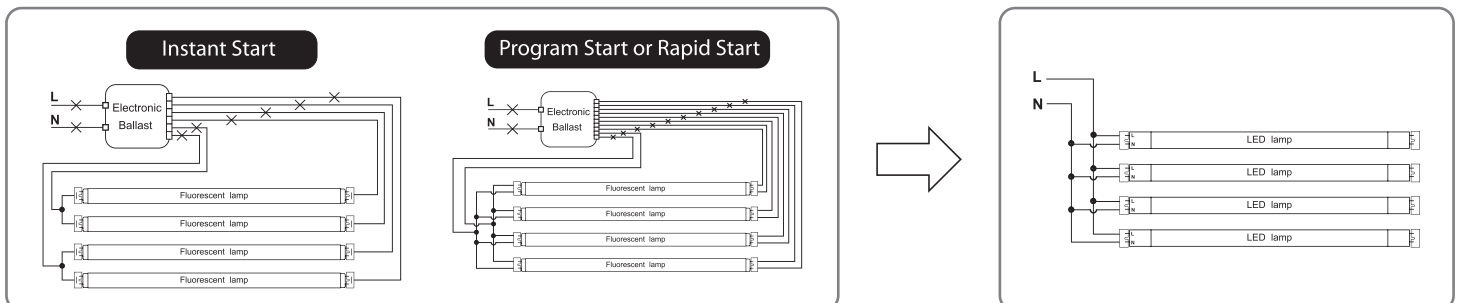

RAB Lighting is committed to creating high-quality, affordable, well-designed and energy-efficient LED lighting and controls that make it easy for electricians to install and end users to save energy. We'd love to hear your comments. Please call the Marketing Department at 888-RAB-1000 or email: marketing@rablighting.com

The below ballast wiring represents typical configuration. The actual ballast wiring varies according to ballast model. It is not needed to change socket (if in good condition) to operate double ended lamps, regardless the type of sockets. Please make sure one side of fixture is connected to Live (L) and the other side to Neutral (N).

Double ended Wiring Instruction

Retrofit luminaire with 1 lamp

Instant Start

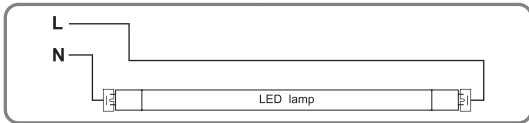
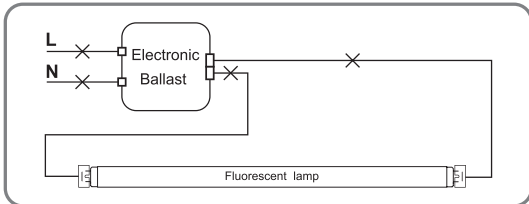

Program Start or Rapid Start

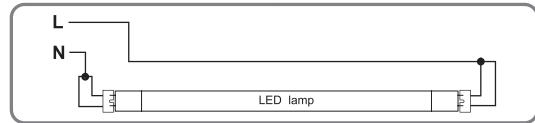
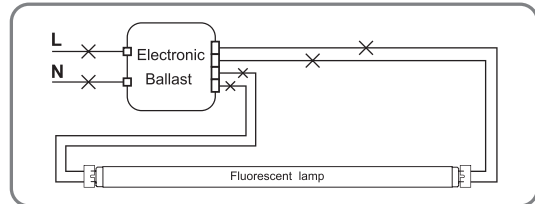

Retrofit luminaire with 2 lamps

Instant Start

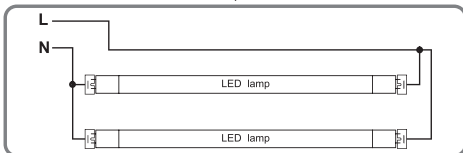
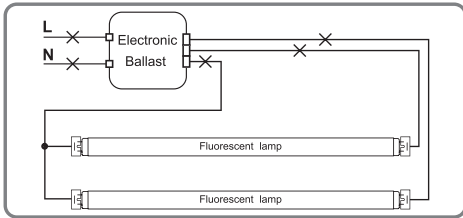

Program Start or Rapid Start

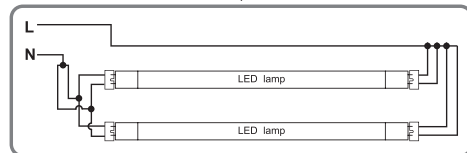
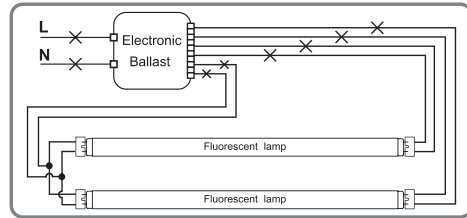

Retrofit luminaire with 3 lamps

Instant Start

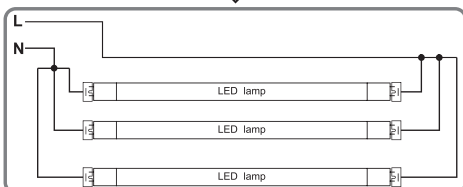
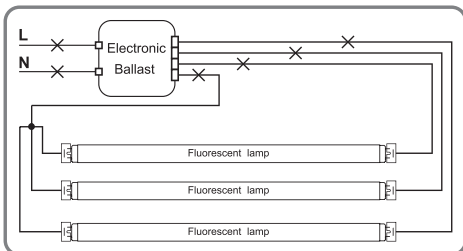

Program Start or Rapid Start

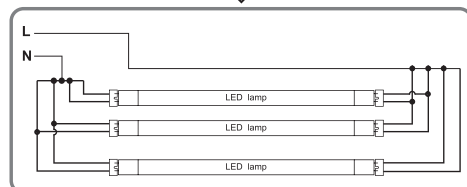
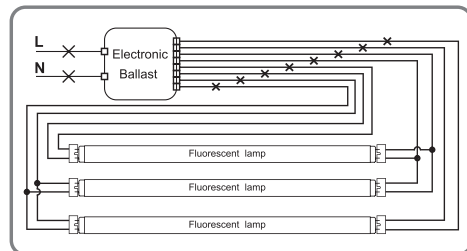

INSTRUCTIONS

LED T8 Tube Series - Double & single ended bypass/line voltage



RAB Lighting is committed to creating high-quality, affordable, well-designed and energy-efficient LED lighting and controls that make it easy for electricians to install and end users to save energy. We'd love to hear your comments. Please call the Marketing Department at 888-RAB-1000 or email: marketing@rablighting.com

Retrofit luminaire with 4 lamps

Instant Start

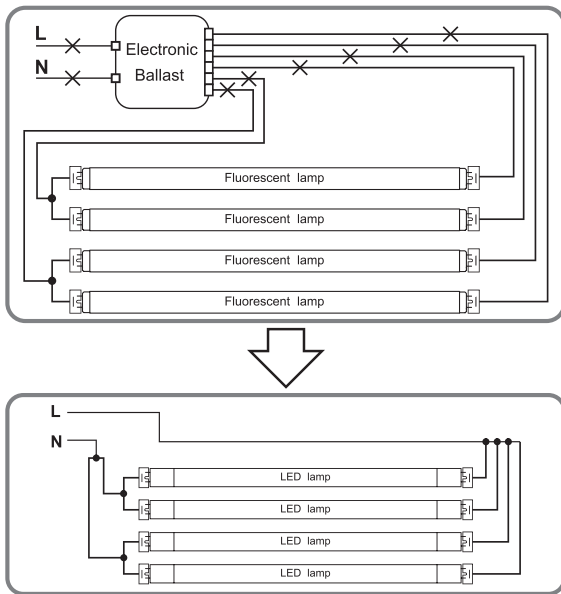

Program Start or Rapid Start

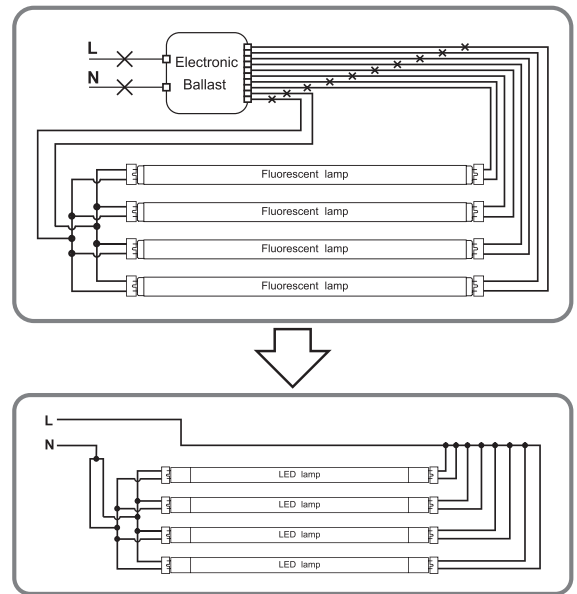

PRODUCT NOTES

The units covered by this report were intended to retrofit surface mount, Type IC or non-IC recessed mount Listed fluorescent luminaires that use maximum 4 tubular lamps, the minimum lamp compartment dimensions are tabulated below:

Model Name	Minimum Lamp Compartment Dimensions [Length x Width x Height] [mm]	Lamp Quantity	Lamp-to-lamp Spacing [cm]
T10263(T8-9-24G-840-SD-BYP USA)	640 x 340 x 45	4	8
T10267(T8-12-36G-840-SD-BYP USA)	920 x 340 x 45	4	8
T10247(T8-10.5-48G-840-SD-BYP USA)	1215 x 605 x 75	4	/
T10251(T8-12-48G-840-SD-BYP USA)	1230 x 340 x 75	4	3
T10255(T8-14-48G-840-SD-BYP USA)	1230 x 340 x 75	4	3
T10259(T8-15-48G-840-SD-BYP USA)	1230 x 340 x 75	4	3

This device complies with Part 15 of the FCC Rules. Operation is subject to the following two conditions: (1) this device may not cause harmful interference, and (2) this device must accept any interference received, including interference that may cause undesired operation.

Note: These instructions do not cover all details or variations in equipment nor do they provide for every possible situation during installation, operation or maintenance.

WARNING

Installers should not disconnect existing wires from lampholder terminals to make new connections at lampholder terminals. Instead installers should cut existing lampholder leads away from the lampholder and make new electrical connections to lampholder lead wires by employing applicable connectors.

Do not make or alter any open holes in an enclosure of wiring or electrical components during kit installation.

THE RETROFIT ASSEMBLY IS ACCEPTED AS A COMPONENT OF A LUMINAIRE WHERE THE SUITABILITY OF THE COMBINATION SHALL BE DETERMINED BY UL OR AUTHORITIES HAVING JURISDICTION.

THERE ARE LED TUBE, OPERATION INSTRUCTION AND FIELD APPLIED LABEL IN THIS RETROFIT KIT.



Easy Answers

rablighting.com
Visit our website for product info

Tech Help Line
Call our experts: 888 722-1000

e-mail
Answered promptly - sales@rablighting.com

Free Lighting Layouts
Answered online or by request

RAB WARRANTY: RAB's warranty is subject to all terms and conditions found at rablighting.com/warranty.